

# SOCCER TABLE

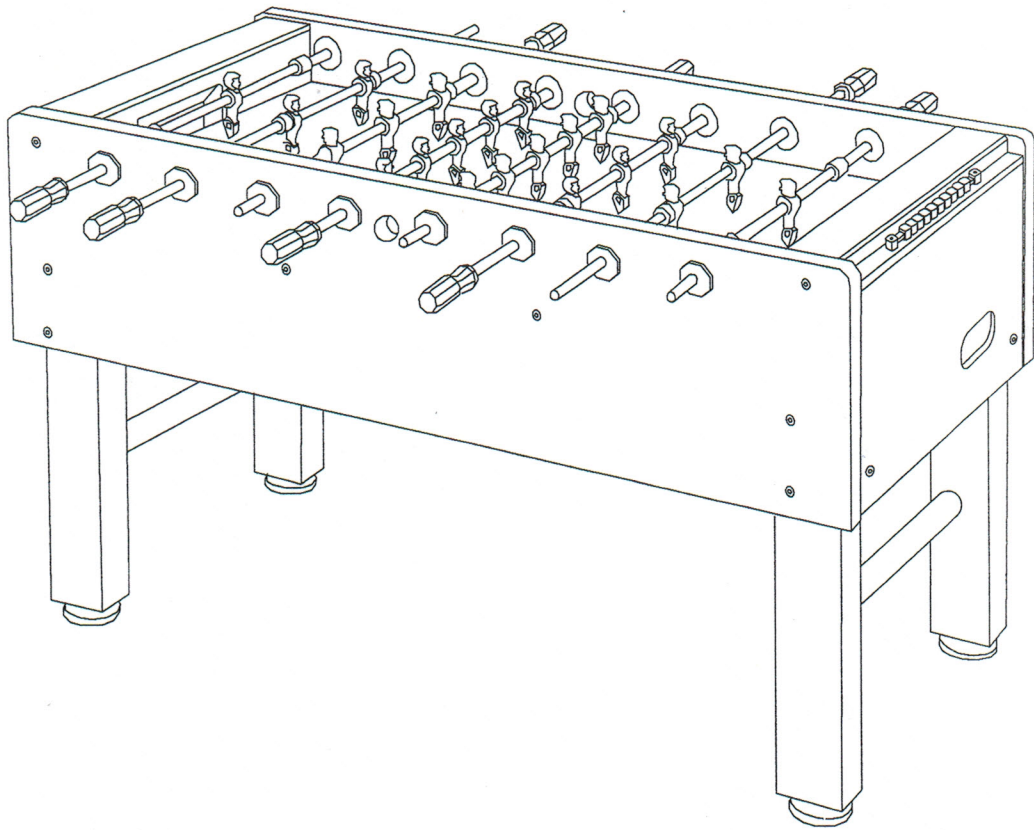











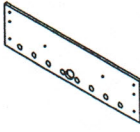
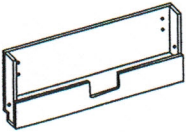
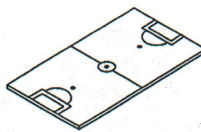
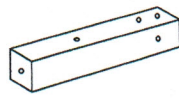
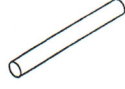
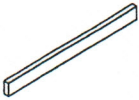













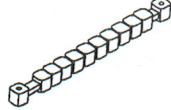
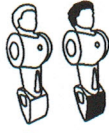
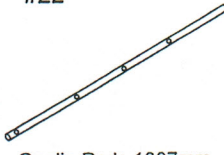







• Assembly/Instructions/Rules •

# **Congratulations! We hope that you receive many years of safe family fun with your new soccer table.**

**\*\* Please carefully read all safety and installation instructions prior to proceeding with the table assembly \*\***

- 1) Your table is designed for use in a climate controlled indoor environment only. Damage can occur if the table is exposed to water, dampness, high humidity, freezing temperatures, etc:
- 2) Due to the weight of the table, it is recommended that two or more adults assist with the table assembly.
- 3) The table should be used for its intended purpose only.
- 4) Damaged or worn parts may be dangerous for game users and can compromise the integrity of the table. The table should not be used until damaged or worn components are replaced with comparable spare parts.
- 5) Unauthorized repairs or altering the tables design/functions may be dangerous and will void your factory warranty.
- 6) Periodically check all screws, bolts, etc. to ensure that they are in good working order and have not loosened over time.
- 7) Please keep the balls, lubricant and other small parts out of the reach of young children and pets.
- 8) Use care when pushing or pulling on the rods so players, spectators or objects nearby do not get poked, injured or damaged. Adult supervision is recommended when the table is being used by children.

# Part List

<p>#1</p>  <p>Long-side Boards 2PCS</p>	<p>#2</p>  <p>Short-side Boards 2PCS</p>	<p>#3</p>  <p>Playfield 1PC</p>	<p>#4</p>  <p>Left Legs 4PCS</p>	<p>#5</p>  <p>Chrome Steel Bars 2PCS</p>
<p>#6</p>  <p>Support sticks 2PCS</p>	<p>#7</p>  <p>5/16*1-1/2" Bolts 4PCS</p>	<p>#8</p>  <p>5/16" Spring Washers 4PCS</p>	<p>#9</p>  <p>5/16" Washers 4PCS</p>	<p>#10</p>  <p>M8*22mm Bolts 8PCS</p>
<p>#11</p>  <p>744mm Steel Sticks 4PCS</p>	<p>#12</p>  <p>F4*1-1/2" Screws 4PCS</p>	<p>#13</p>  <p>3/8*5-1/2" Bolts 4PCS</p>	<p>#14</p>  <p>3/8*5-1/4" Bolts 8PCS</p>	<p>#15</p>  <p>3/8" Washers 12PCS</p>
<p>#16</p>  <p>3/8" Spring Washers 12PCS</p>	<p>#17</p>  <p>3/8" Nuts 12PCS</p>	<p>#18</p>  <p>8*1-1/4" Bolts 22PCS</p>	<p>#19</p>  <p>Nuts 26PCS</p>	<p>#20</p>  <p>Counters 2PCS</p>
<p>#21</p>  <p>Players 22PCS</p>	<p>#22</p>  <p>Goalie Rods 1097mm 2PCS</p>	<p>#23</p>  <p>2-Man Rods 1271mm 2PCS</p>	<p>#24</p>  <p>5-Man Rods 1028mm 2PCS</p>	<p>#25</p>  <p>3-Man Rods 1142mm 2PCS</p>
<p>#26</p>  <p>Rod End Caps 8PCS</p>	<p>#27</p>  <p>Bumpers 16PCS</p>	<p>#28</p>  <p>Plastic Washers 16PCS</p>	<p>#29</p>  <p>Rod Handles 8PCS</p>	<p>#30</p>  <p>Leg Levelers 4PCS</p>
<p>#31</p>  <p>Soccer Balls 4PCS</p>	<p>#32</p>  <p>Lubricant 1PC</p>	<p>#33</p>  <p>WP4*1-1/2" Screws 8PCS</p>	<p>#34</p>  <p>Wrench 1 PC</p>	<p>#35</p>  <p>5mm Allen Keys 2PCS</p>
<p>#36</p>  <p>8*1" Bolts 4PCS</p>	<p>#37</p>  <p>Bushings 4PCS</p>	<p>#38</p>  <p>6mm Wood Tenon 8PCS</p>	<p>#39</p>  <p>Triangle Blocks 4PCS</p>	

# STEP 1

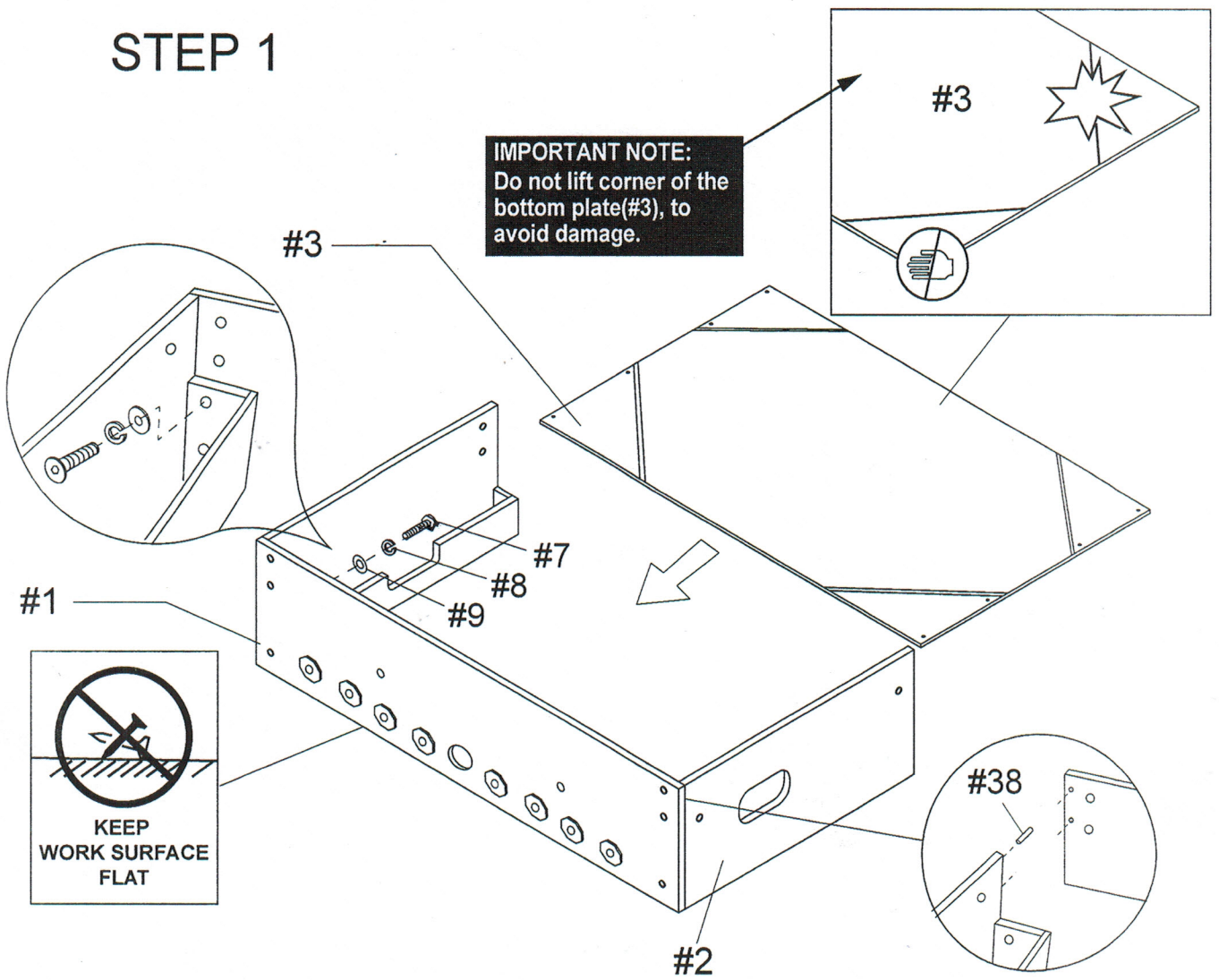

# STEP 2

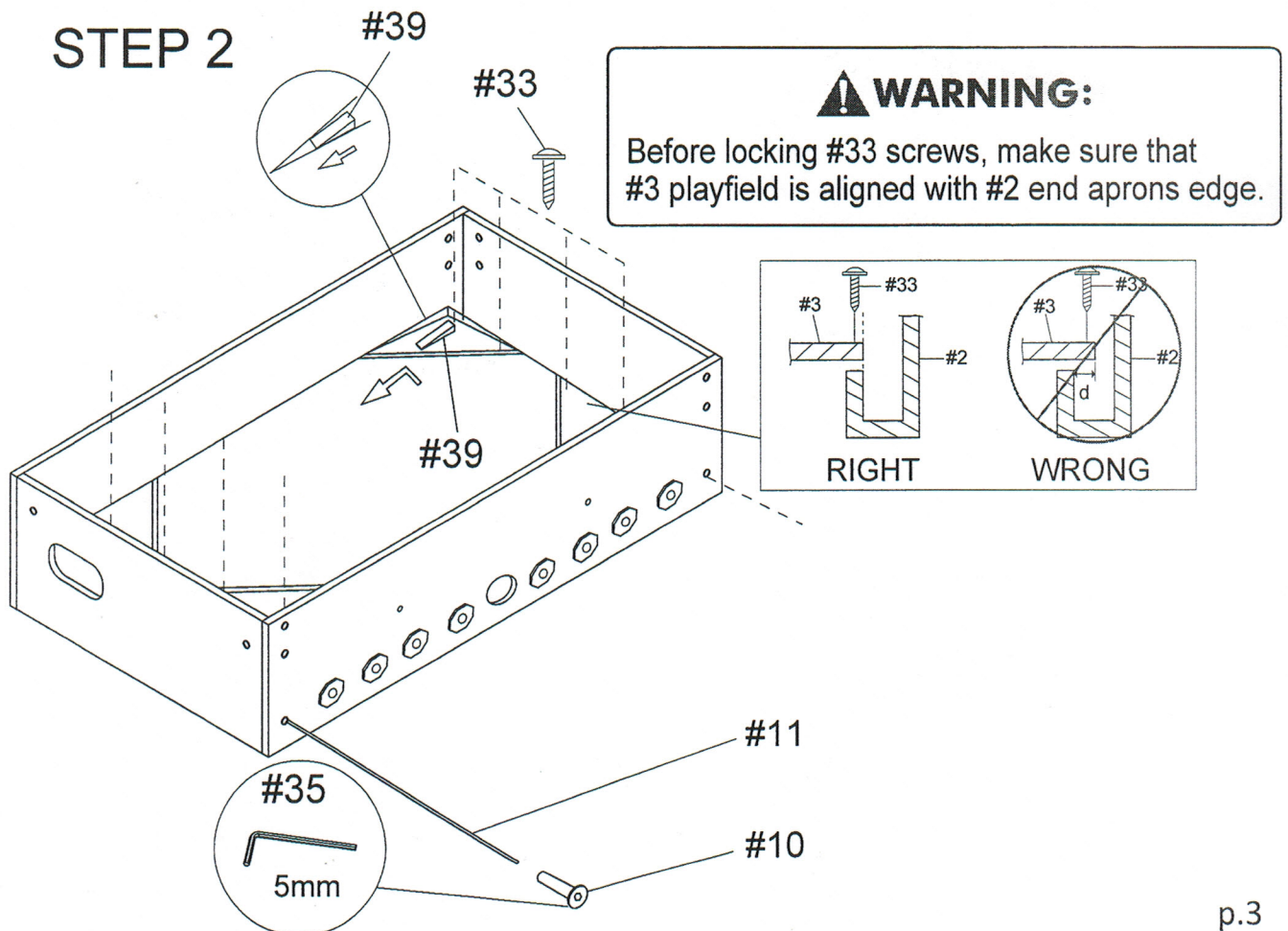

### STEP 3

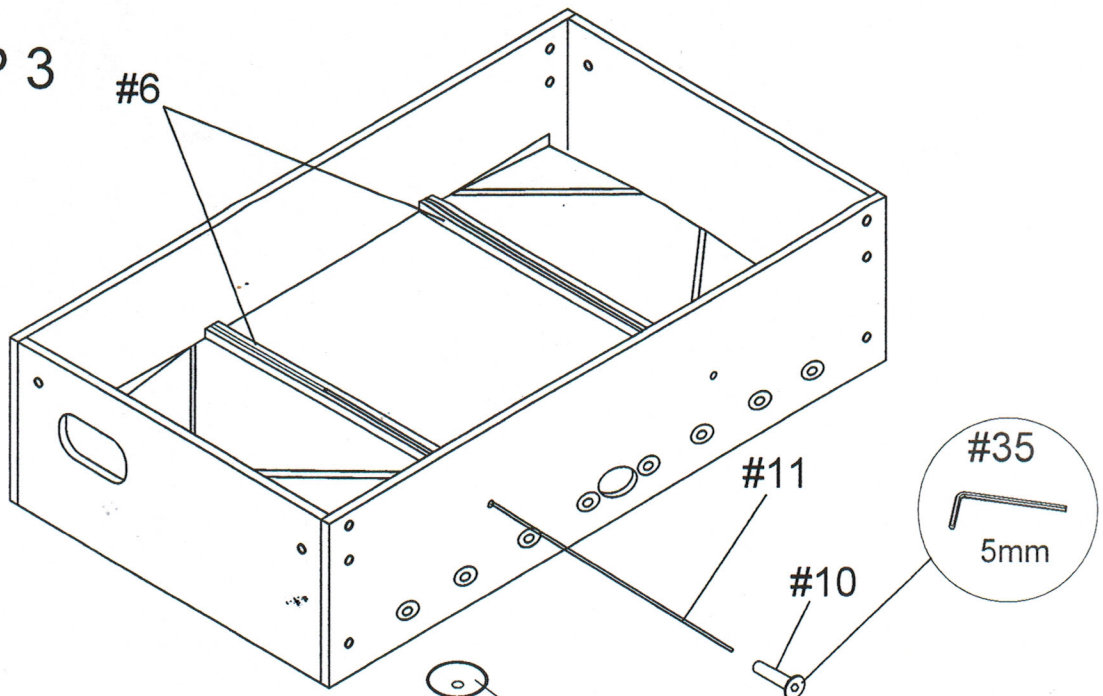

### STEP 4

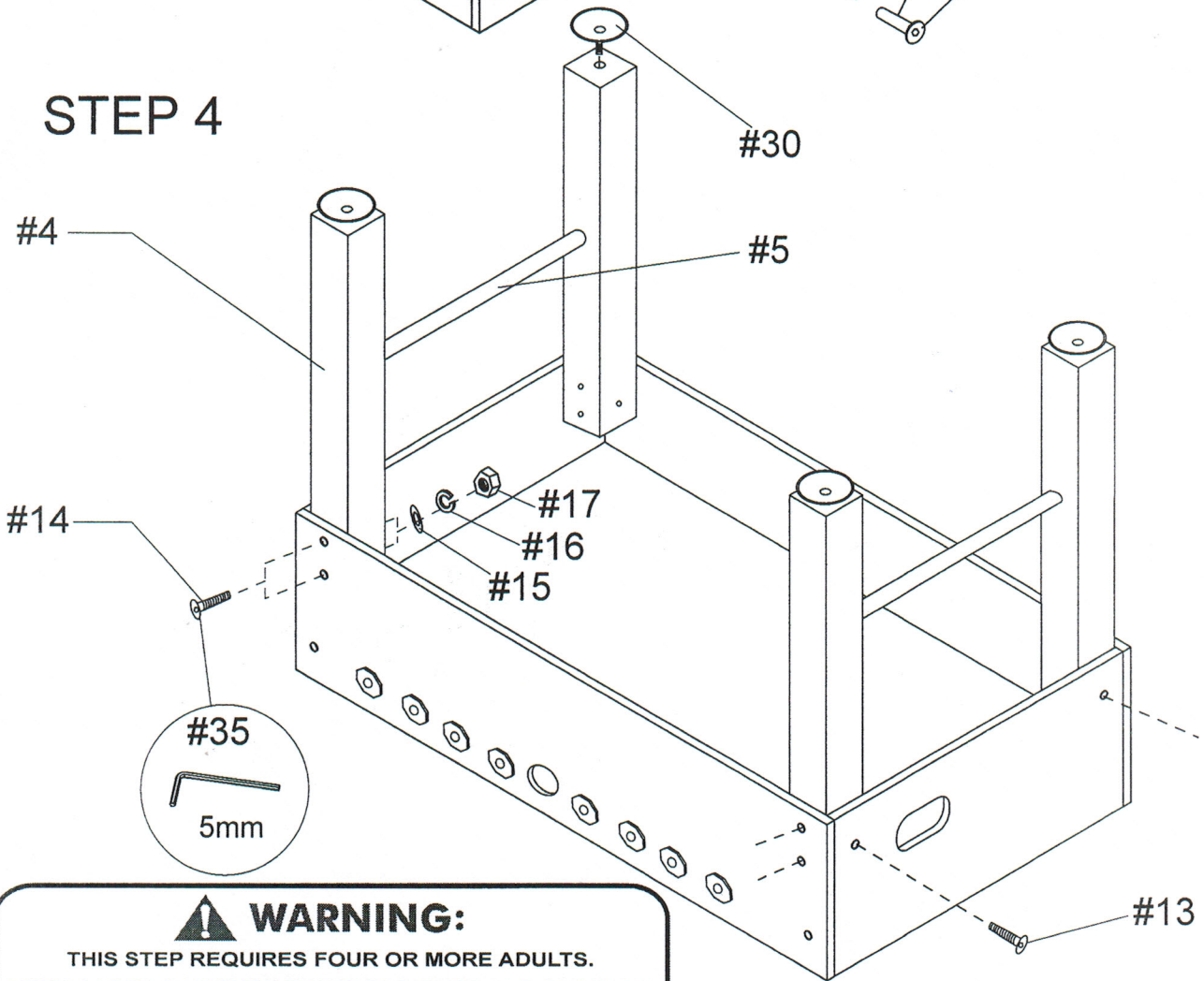

**WARNING:**  
THIS STEP REQUIRES FOUR OR MORE ADULTS.  
VERY CAREFULLY TURN THE TABLE OVER AND SET IT ON  
ITS LEGS. BE CAREFUL. THE TABLE IS VERY HEAVY.

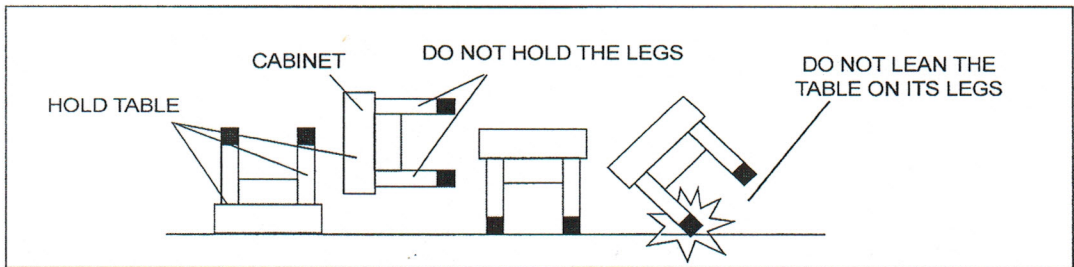

# STEP 5

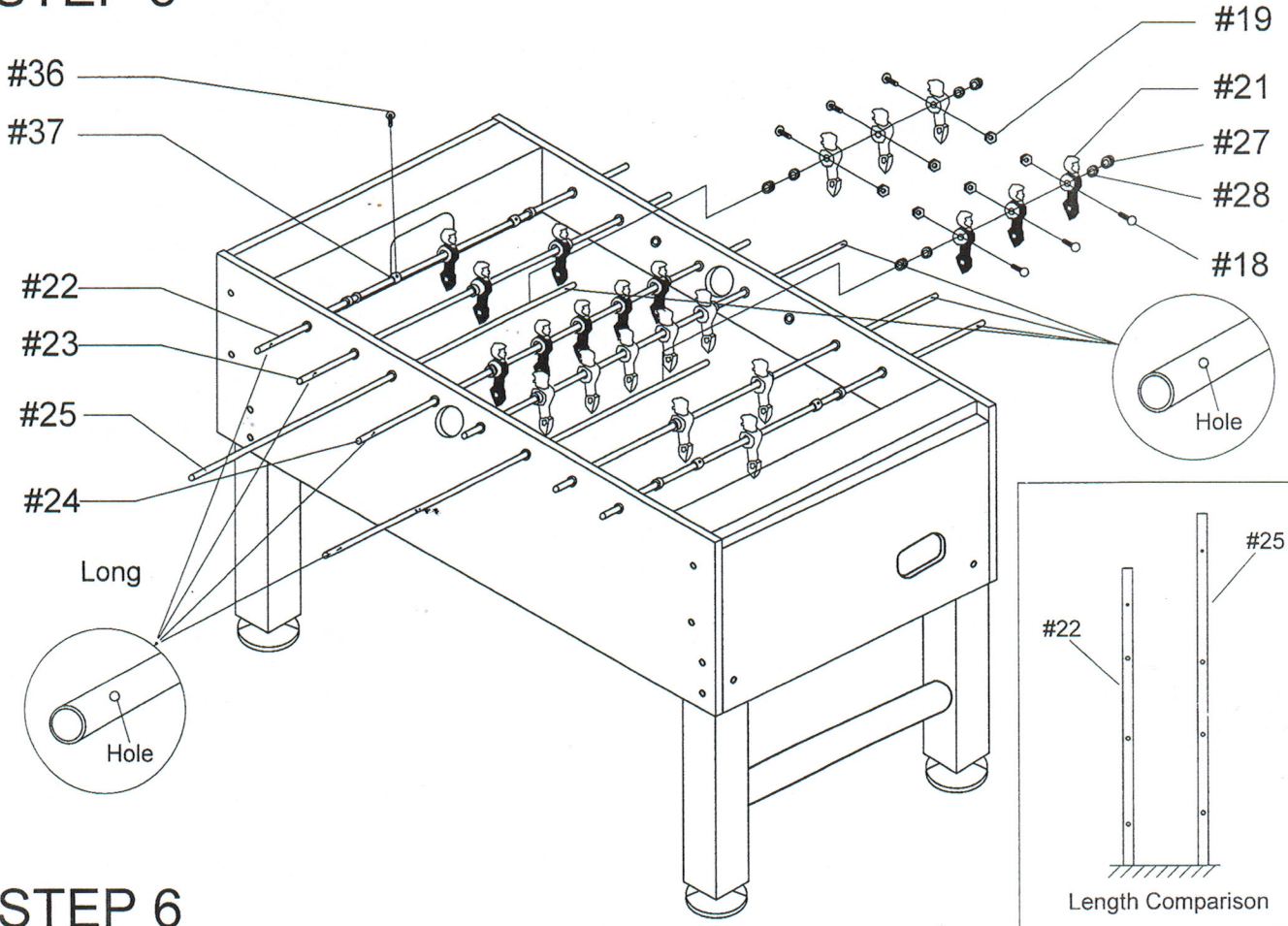

# STEP 6

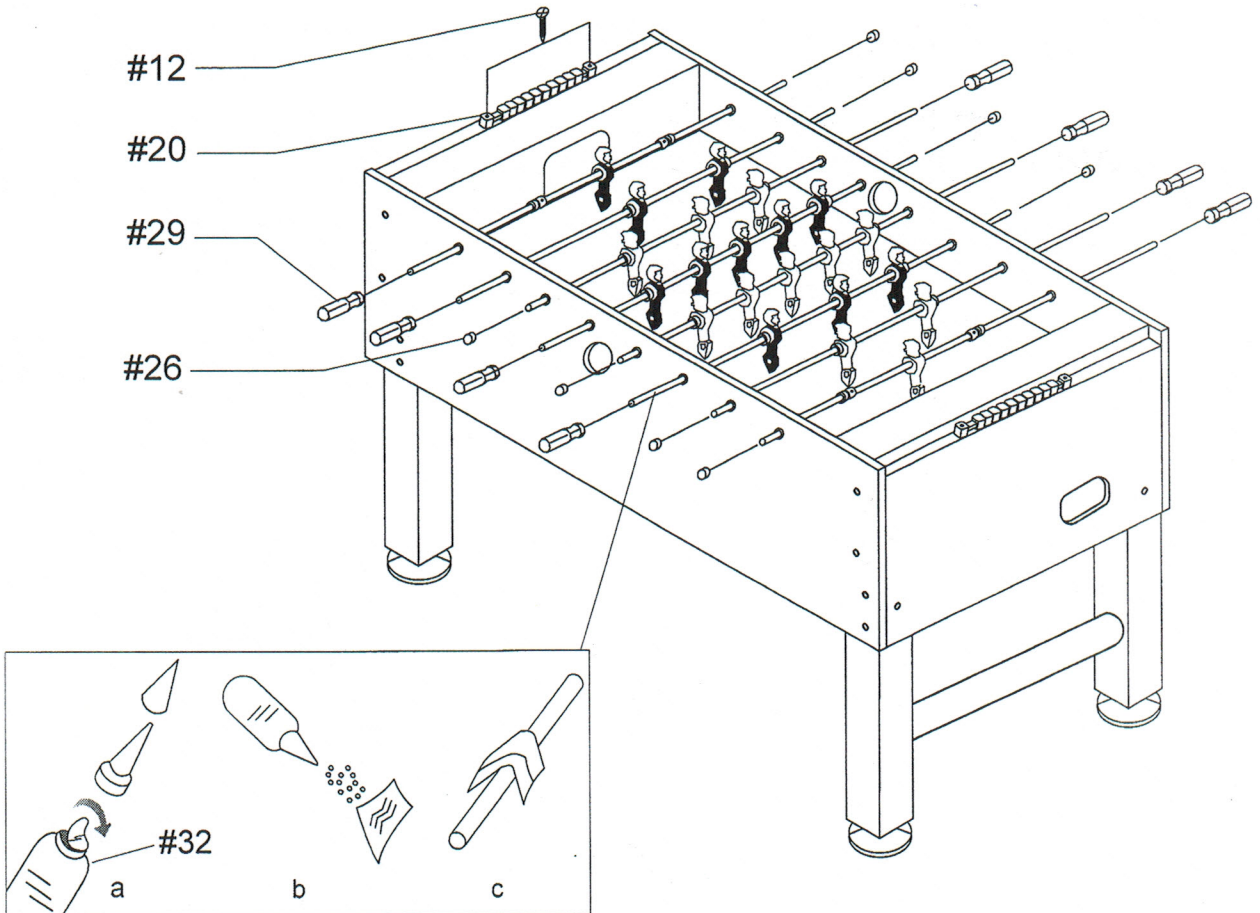

- Spray the lubricant(#32) into a clean, soft cloth and then use the cloth to wipe the player rods where they come into contact with the bearings. See above.

TABLE MAINTENANCE	
<b>TABLE SURFACE</b>	Keep your table covered. If there is dust on the playfield or the aprons, use a vacuum or wipe with a clean, soft cloth to remove. Do not sit on the table and do not use the table outside.
<b>RODS</b>	Occasionally wipe the rods with a clean, soft cloth. Never lift the table by the rods. Do not spin or press the rods too aggressively, as this may cause damage. We recommend the use of lubricant to wipe the Player Rods and Bearings from the outside of the game so as not to drip onto the playfield.
<b>LEGS</b>	Check that the leg bolts are tight. When moving the table, lift table off of its legs and place it down squarely on the legs, do not drag the table.
<b>METHOD</b>	Please make sure that all the screws, bolts are tightened before using. The table can't be hit by external force or used rough.

# Rules

**Flip A Coin** - A coin flip decides who serves the foosball to start the foosball game. After the first goal is scored, the rule is that the team who was last scored on gets to serve the next ball. This rule keeps the game fair for both opponents. The foosball must be touched by a man before the ball goes into a goal for a legal goal to occur.

**No Spinning** - A spin is a rule for when the rod completes a 360 degree rotation without touching the ball. This is deemed an illegal move in the rules of foosball.

**No Jarring** - Jarring is a rule for when a player slams his or her rods against the wall of the foosball table in an attempt to distract or jar the foosball loose from the other player's possession. The rule is that there is no jarring allowed at any point during a game. This is not the same as when a player on the opposite team moves his or her foosball rods back and forth in an attempt to play defense. The key this rule is when a player hits the wall of the table with enough force to jar the ball or distract the opponent. That is why this is a subjective rule that may be called more strict by certain foosball players.

**Dead Balls** - If a foosball stops in the middle of two opposing team rods, the ball must be picked up and reserved. The serve goes back to the team that was last scored on. If a dead ball occurs on the defensive side of the table behind the defensive 2 bar, the defensive player must move the ball back into playing position. This rule is in place so players don't cause a dead ball on purpose in order to force a reserve.

**Out of Play** - If a ball comes off the table area or hits a top rail and comes back into the table area, the ball is ruled out of play and must be reserved by the team that was last scored on.

**5 Bar Passing** - These 5 bar passing rules are a little complex if you have never played tournament foosball. These passing rules do not apply to the other foosball rods, just the 5 bar. You are required to pass the ball within a 10 second time period from your 5 bar rod to the 3 bar rod directly after a serve. After the initial serve, you then are allowed 15 seconds to pass from the 5 bar. A ball cannot be completely stopped on the 5 bar and passed forward to the 3 bar, it must be moving and touch 2 men on the 5 bar before being advanced. Additionally, the ball can only touch the wall a total of 2 times in a row (before touching a man again on the 5 bar) before being advanced. However, it can touch the ball a 3rd time if it is part of the pass.